

HPA
"Analog Turned-off"
at CBS / CW
2 / 17 / 2009

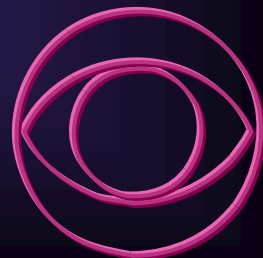

Robert P. Seidel

CBS Television Network

V.P. Engineering & Technology

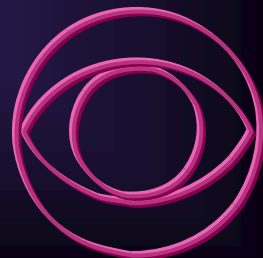

CBS HDTV PRIME TIME 2008/2009

	7:00	7:30	8:00	8:30	9:00	9:30	10:00	10:30
sunday	60 Minutes		The Amazing Race		Cold Case		The Unit	
monday			The Big Bang Theory	How I Met Your Mother	Two & a Half Men	Worst Week	CSI: Miami	
tuesday			NCIS		The Mentalist		Without a Trace	
wednesday			The New Adventures Of Old Christine	Gary Unmarried	Criminal Minds		CSI:NY	
thursday			Survivor		CSI		Eleventh Hour	
friday			Ghost Whisperer		Flashpoint		Numb3rs	
saturday			Crime Time Saturday		Crime Time Saturday		48 Hours	

 Simulcast in HDTV

 Simulcast in HDTV & 5.1 Surround Sound

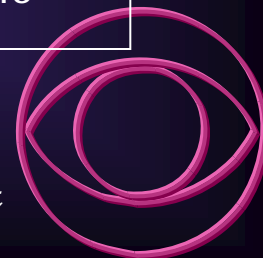

CW HDTV PRIME TIME 2008/2009

	7:00	7:30	8:00	8:30	9:00	9:30	10:00
<i>sunday</i>	In Harm's Way		Valentine		Easy Money		
<i>monday</i>			Gossip Girls		One Tree Hill		
<i>tuesday</i>			90210		Privileged		
<i>wednesday</i>			America's Next Top Model		Stylista		
<i>thursday</i>			Smallville		Supernatural		
<i>friday</i>			Everybody Hates Chris	The Game	America's Next Top Model		

 Simulcast in HDTV

 Simulcast in HDTV & 5.1 Surround Sound



CBS HDTV Programming

- US Tennis Open in 5.1
- NCAA Football every Saturday in 5.1
- Full NCAA Basketball Tournament coverage from 1st Round to the Final Four in 5.1
- All NFL Football games on Sunday in 5.1
- Superbowls.
- PGA Golf in HD & 5.1.
- The Masters in HD & 5.1
- 21 of 21 primetime dramas and sitcoms.

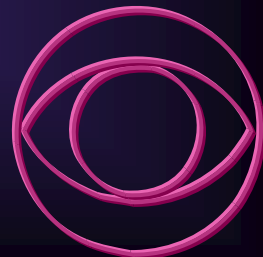

CBS HDTV Programming

- In June 2001 CBS announced, "*The Young and The Restless*", the number one daytime drama.



- *The Late Show with David Letterman* Sept 2005.
- *The Price is Right* in Q1 2008.
- *The Evening News With Katie Couric* July 28, 2008.
- *60 Minutes* in the Fall 2008.
- *Survivor* in the Fall 2008.

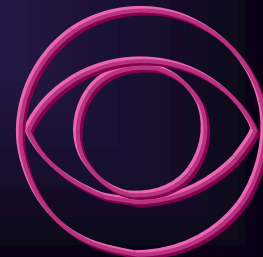

CBS HDTV Programming

- 2003-2008 Grammys in HDTV and 5.1 Surround Sound with over 800 individual audio sources.
- 60 hours per week of original HD programming.
- Daytime programming, Primetime, Sports, Movies and Specials.
- Owned & Operated stations are producing HD News in NY, LA, San Fran, Philly, Denver, Chicago.

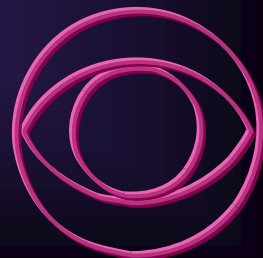

2000 CBS TV Network Signal Flow

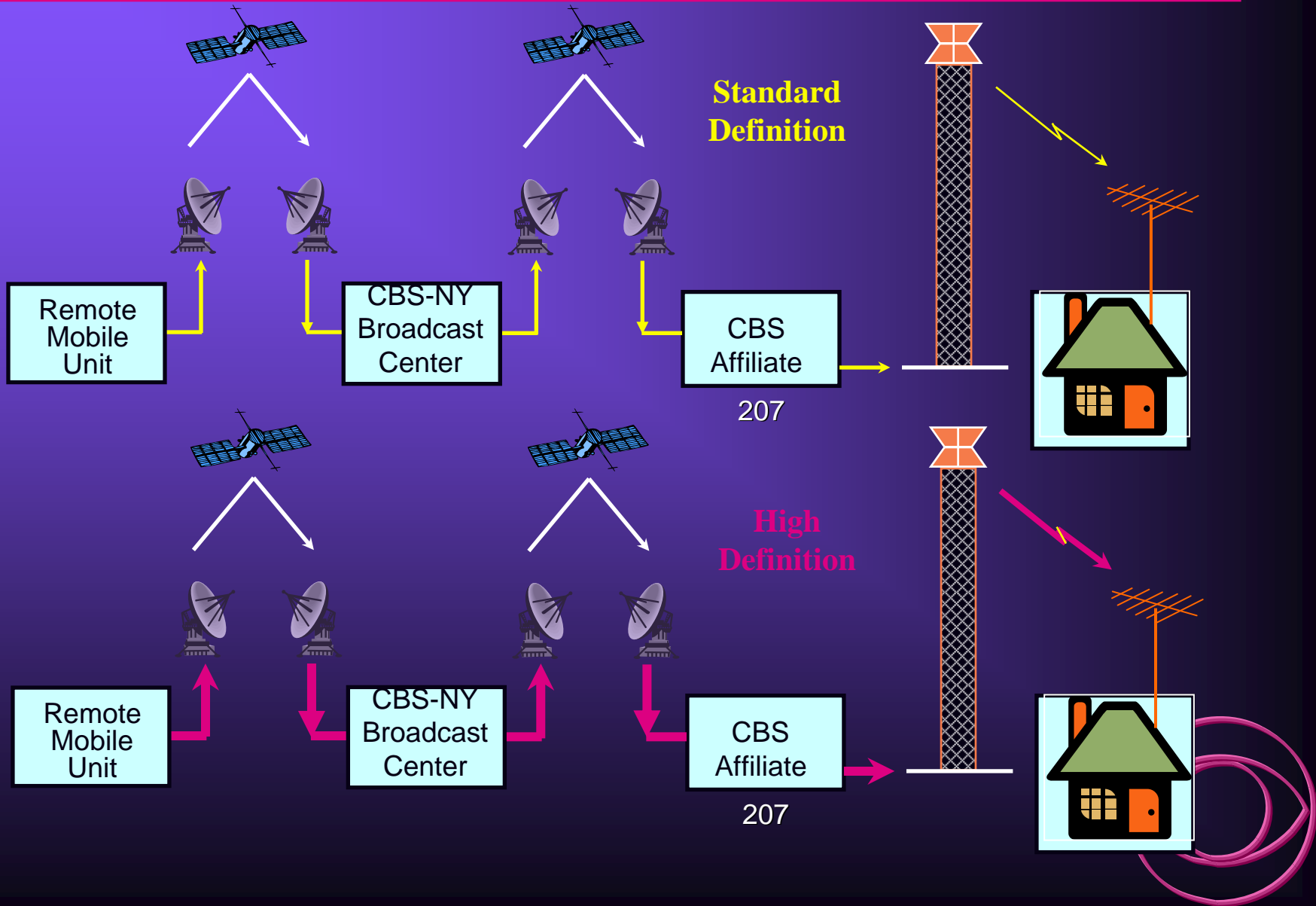

2005 CBS TV Network Signal Flow

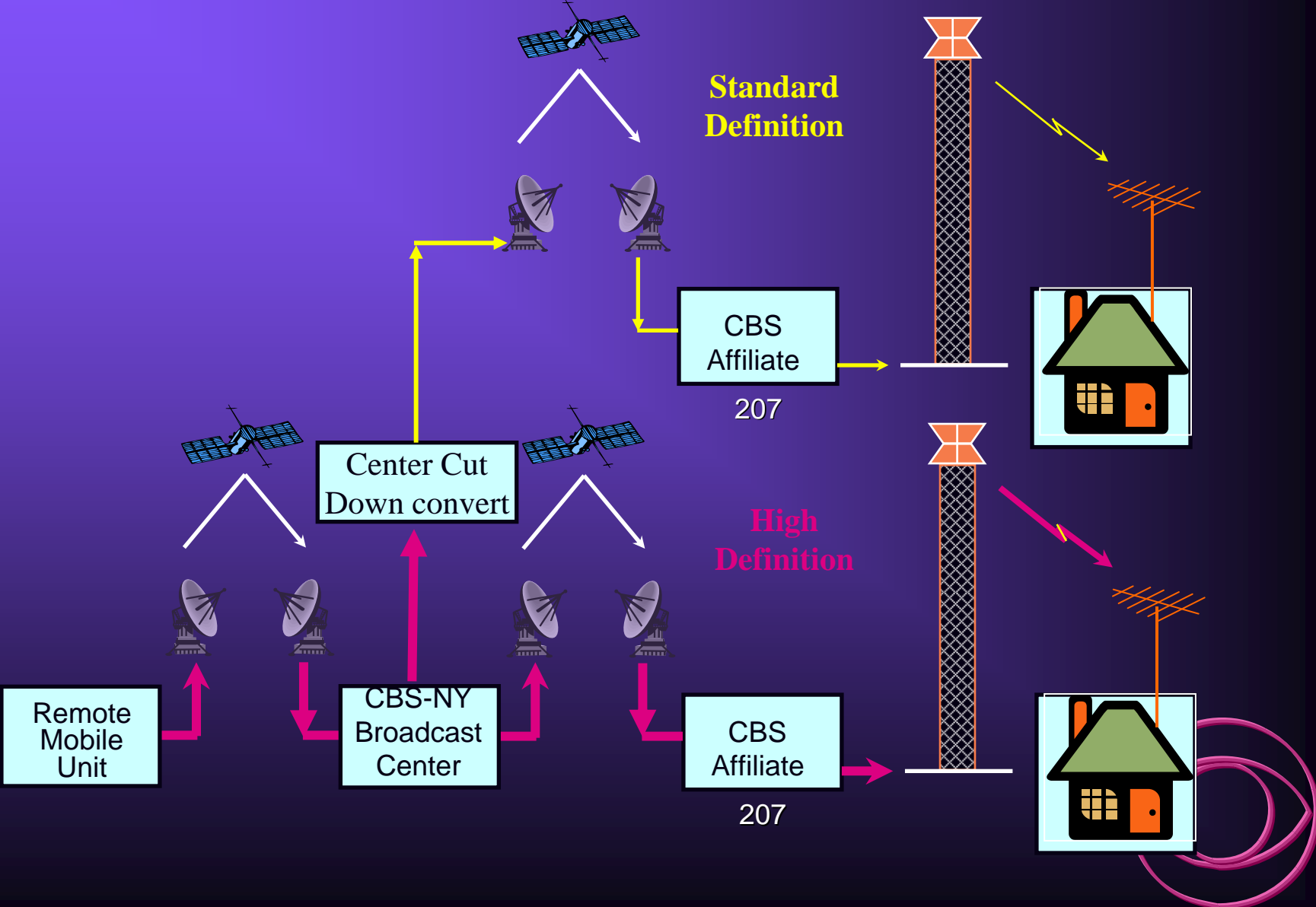

2006 CBS TV Network Signal Flow

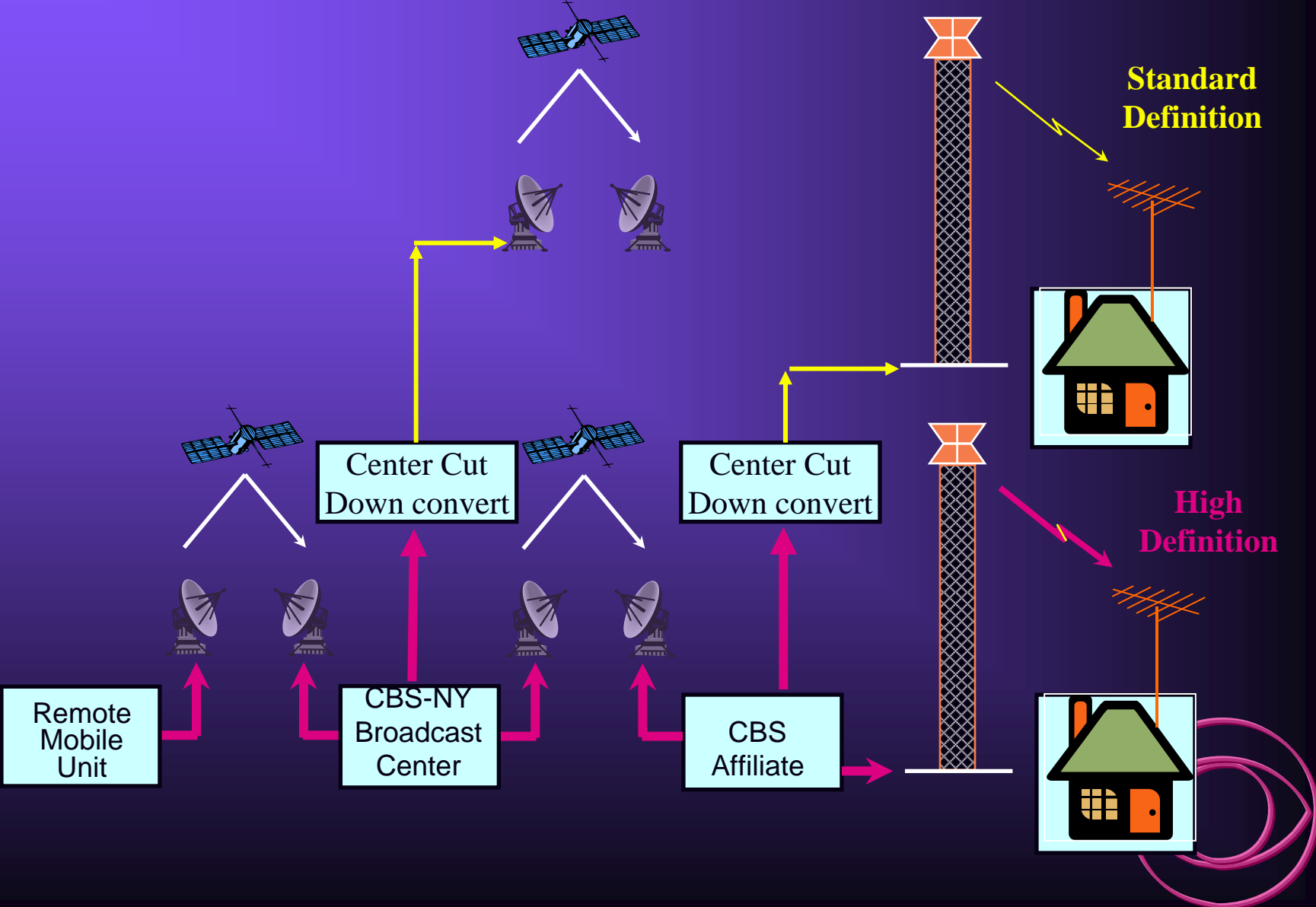

2009 CBS TV Network Signal Flow

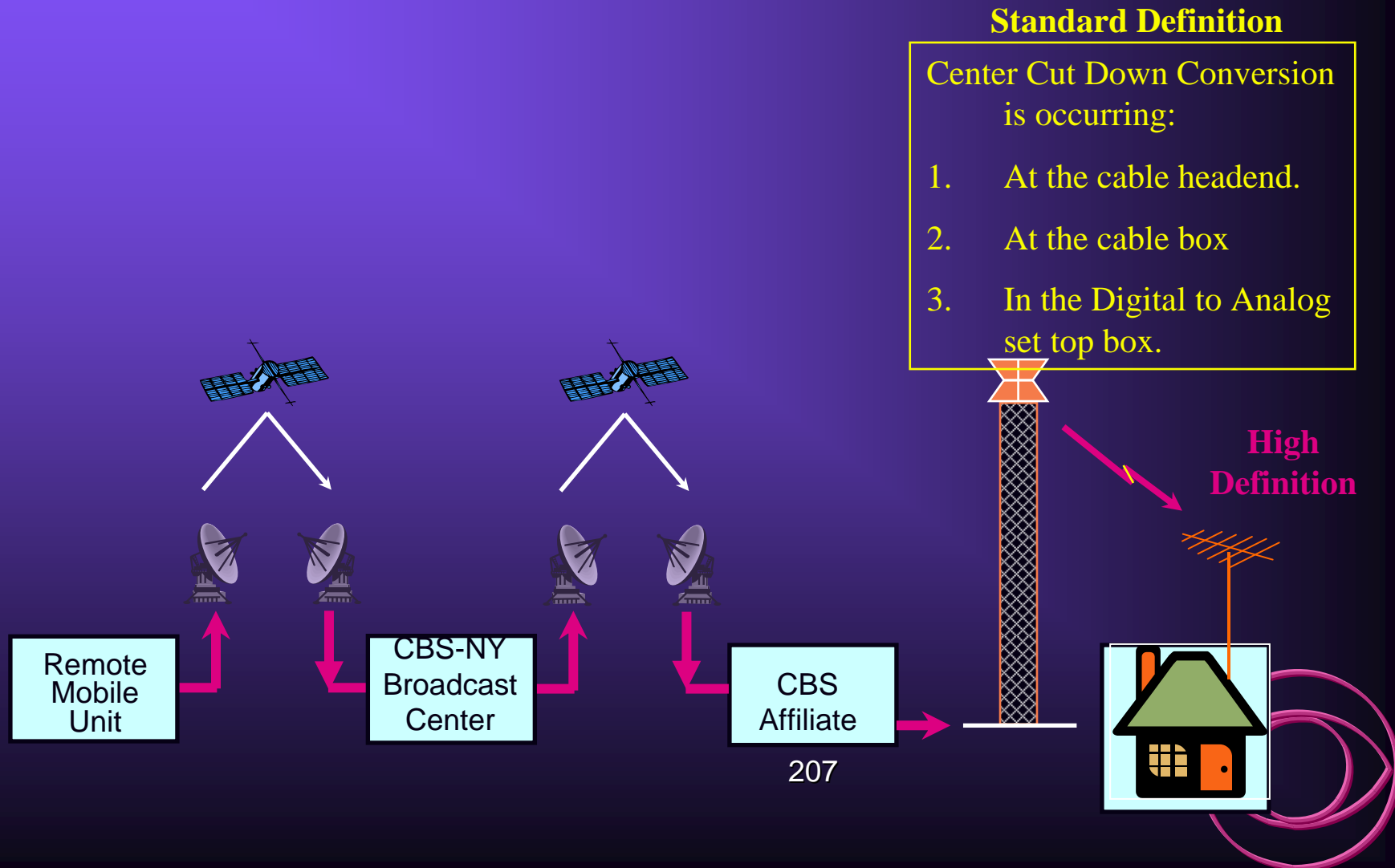

2000 Cable TV Signal Flow

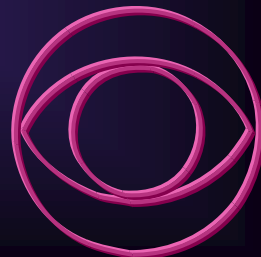
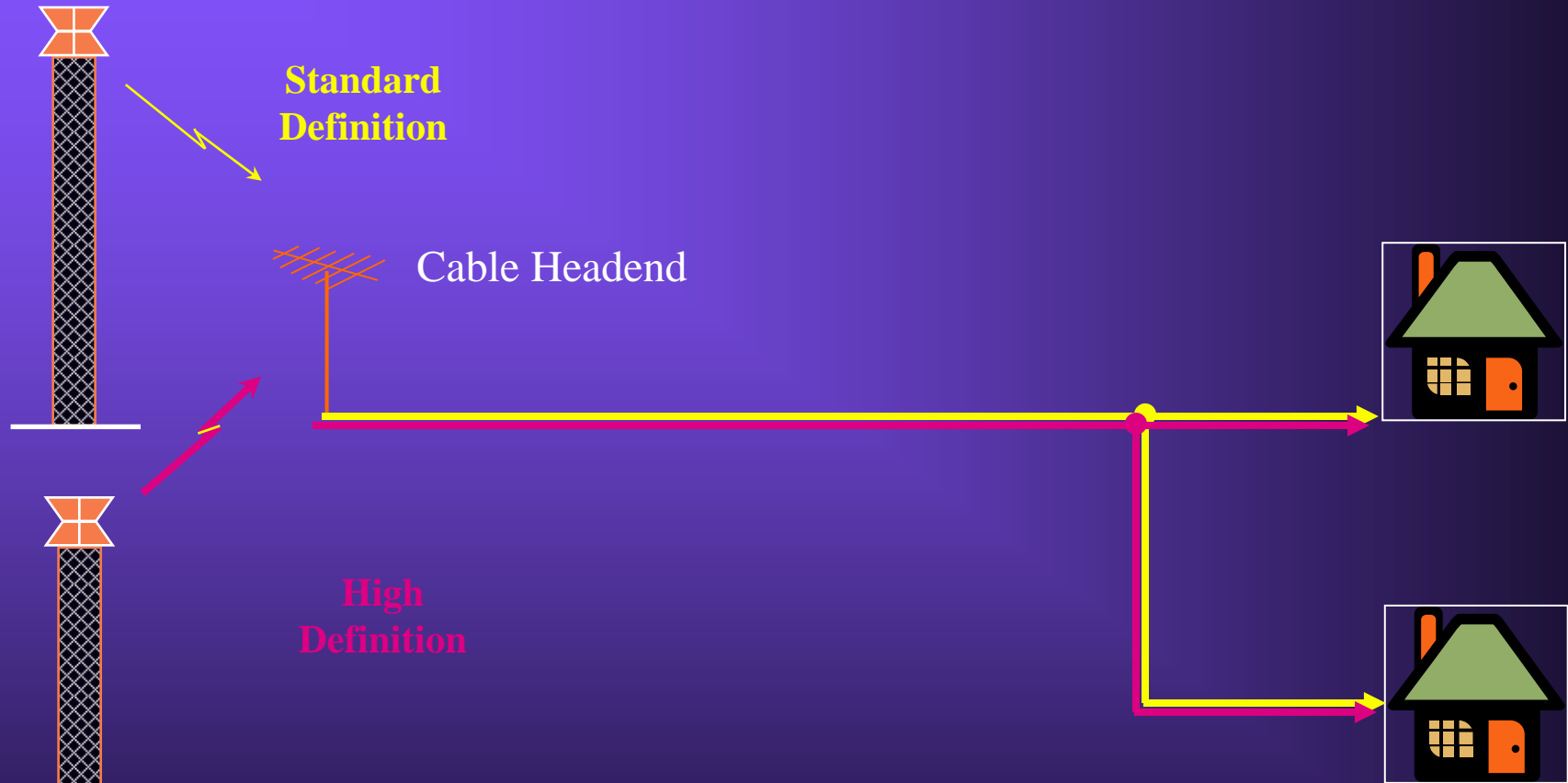

2008 Cable TV Signal Flow

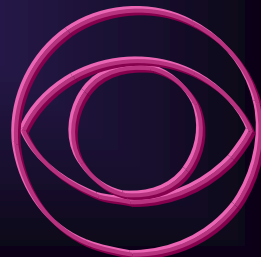
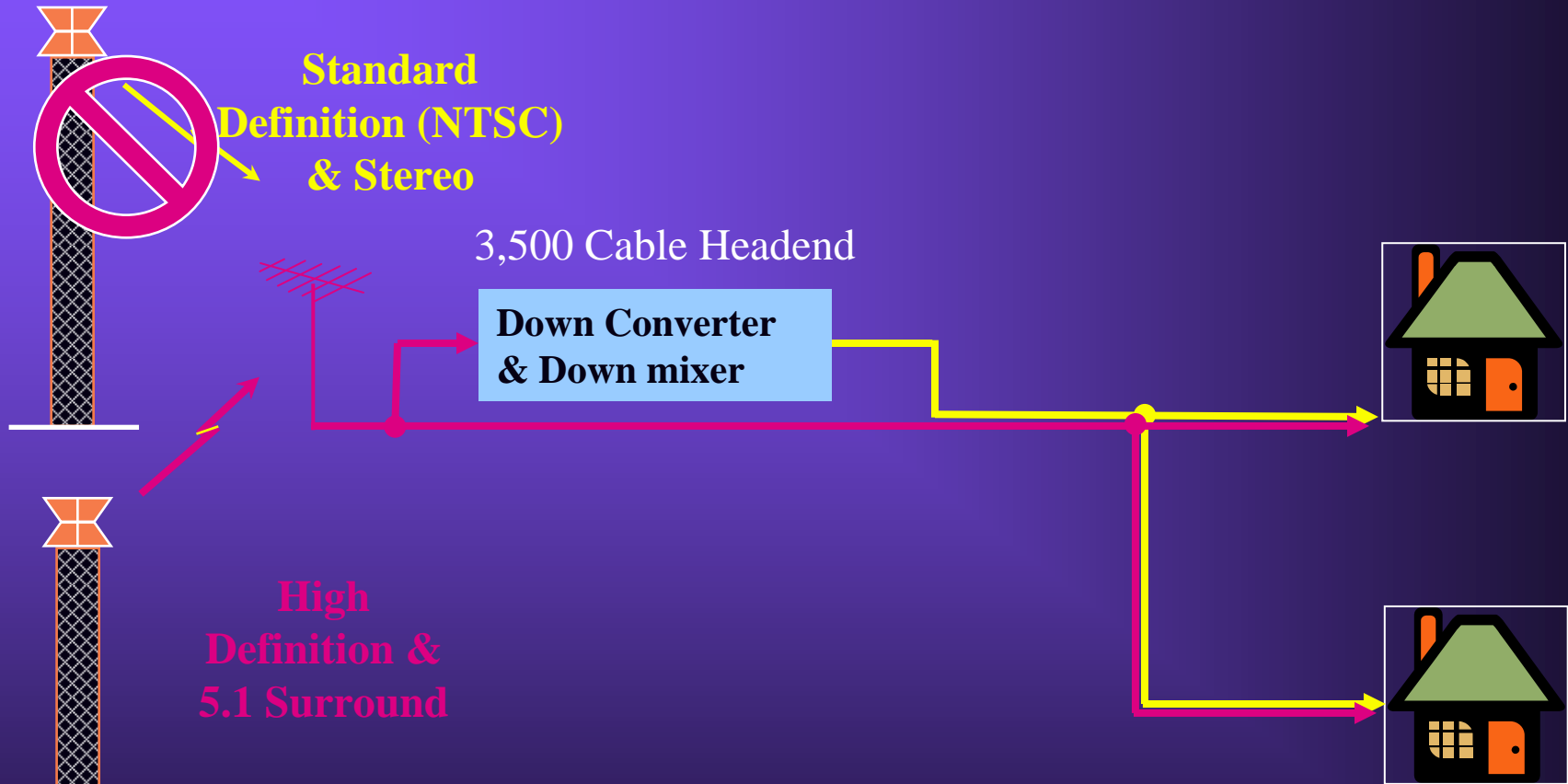

DTV Delay Act of 2009

- Mandatory analog NTSC transmitter shut down date has been moved to June 12th 2009.
- Stations may elect to shut down on February 17th 2009.
- 681 have applied for early turn off.
- 102 stations / markets must meet additional FCC requirements.
- All CBS & CW Owned and Operated analog stations will remain on-the-air until June 12th 2009.

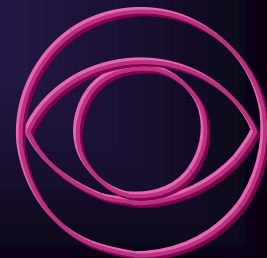

681 Stations Applied for 2/17/09 Turn off

Network Affiliation	# of Stations
ABC	79
CBS	85
CW	38
Fox	86
ION	88
MYTV	35
PBS	139
Telemundo	2
Univision	8
IND	38
other	76
Total	681

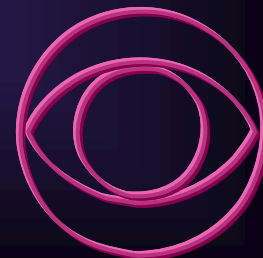

New FCC Requirements for 123 stations

- **Enhanced Nightlight-** one station must remain on the air with emergency info, news, and public affairs programming.
- Programming provided in **English & Spanish.**
- Provide info describing **areas affected.**
- Each station individual or collectively must commit to **telephone hotline** to help viewers.
- **Walk-in center** to assist with coupons, converter boxes.
- **Run a text crawl** from 2/10 thru 2/17; 5 minute announcement every hour, 5 days before shutdown. 2 days before shut down, run a 10 minute text crawl per hour.
- Station **out reach program.**



Thank You

